

# LIQUID CONTROLS GROUP



## Positive Displacement Meters and Accessories



## Premier products, premier performance

### Applications

#### Truck metering

- Refined fuels
- LPG
- Aviation fuel
- Alternative Fuels
- Lube oils
- Agricultural chemicals

#### Bulk plant/terminal metering

- Crude petroleum products
- Refined petroleum products and LPG
- Alternative Fuels
- Industrial chemicals/solvents
- Marine fuel/bunker oil
- Hot Asphalt/Asphalt Emulsions

#### Dispenser metering

- LPG and diesel fuel

#### Industrial process metering

- Liquid sweeteners/corn syrup
- Paints and coatings
- Pulp and paper
- Pharmaceuticals
- Printing inks
- Concrete add mixtures
- Industrial liquids

Liquid Controls is a world renowned supplier of reliable, high-accuracy, positive displacement (PD) metering systems. Whether your business requires flow measurement for custody transfer or process control, with an LC PD meter on your delivery vehicle, at your bulk shipping facility, or at your plant, you'll get years of consistently accurate, trouble-free service. Because of the ease of installation, minimal maintenance, and few replacement parts, you'll appreciate the low cost of owning and operating LC positive displacement meters.

#### Features and benefits

LC meters are exclusively engineered with no metal-to-metal contact within the measuring chamber, making use of a thin liquid capillary film between rotating and stationary components for hydraulic sealing. This unique design results in **minimal wear, sustained accuracy,** and **low operating costs.** When measuring the flow of a broad range of products, LC's innovative design results in minimal resistance to flow and the ability to operate on pump pressure or gravity feed. That means efficient performance and **low pressure drop** across the meter. LC's combination of low pressure drop with minimum seal or slippage area offers better accuracy over a wide range of flow than other commercially produced PD meters.

The simplicity in design and high quality manufacturing make LC meters more reliable and less costly to operate than other meters. Multiple installation configurations provide greater mounting versatility. In many cases, you can replace your existing meter with an LC meter with minimal disruption to system piping and components.



*LC's three-rotor positive displacement measuring chamber.*



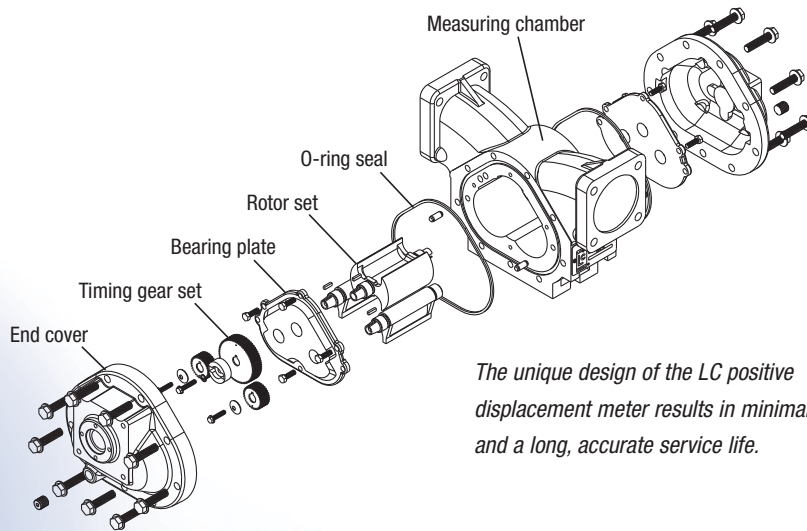

*The unique design of the LC positive displacement meter results in minimal wear and a long, accurate service life.*

### System accessories

Liquid Controls' innovation extends beyond meters to system components and accessories. Precision-engineered and manufactured LC strainers, air eliminators, and valves provide unsurpassed performance across a wide range of liquids and applications.

LC meters are also available with your choice of mechanical or electronic registers. Our state-of-the-art family of LectroCount™ electronic registers provide your meter with automated control and data management capability to improve productivity, lower your costs, and increase your profits.

At Liquid Controls' ISO-certified facility in Lake Bluff, Illinois, LC metering systems are manufactured to last. Meters crafted with quality decades ago are still in operation today. Our metering systems are sold and serviced by a worldwide network of qualified distributors and OEMs. They're backed by our reputation for quality, accuracy, and reliability. That's why Liquid Controls continues to lead the industry in Weights and Measures-approved custody transfer metering, and why you'll want your business to include Liquid Controls products.

### The LC metering element

- Provides custody transfer accuracy
- Performs well with a wide range of liquids, from low viscosity to high viscosity
- Minimizes inaccuracies due to clearance changes and wear common to other meter designs
- Performs with equal accuracy when flow is in either direction (forward or reverse)
- Operates without axial thrust on rotor bearings for longer life
- Adapts to multiple installation positions
- Includes Weights and Measures approvals, worldwide

#### Linearity (over 10:1 range)

Capable of ±0.10% (electronic registration)  
Capable of ±0.22% (mechanical registration)

#### Repeatability

Capable of 0.03% (±.015%)

For complete specifications, refer to page 8.

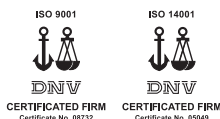

# Meters

LC meters are known worldwide for exceptional accuracy, reliability, and longevity in a broad range of applications. From truck applications metering refined petroleum products and LPG, to process applications metering a wide range of industrial liquids.

## Truck meters

For custody transfer applications requiring Weights and Measures-approved accuracy, Liquid Controls M and MA Series truck meters provide the industry's most time-proven and respected records of superior value and performance. LC truck meter accessories include air eliminators, strainers, valves, and a choice of mechanical or electronic registers and printers for presetting, totalizing deliveries, and printing tickets.

Typical applications of the LC meter and accessories include tankwagons delivering fuel to homes for domestic heating or gasoline to service stations; bobtails delivering LPG to homes and farms; and aviation refuelers delivering avgas or jet fuel into aircraft. Other applications include metering of anhydrous ammonia and other farm-related products from vehicle-mounted tanks.



*M-7 with electronic registration for refined fuels (with E-7 valve, optical air eliminator, and high-capacity air eliminator)*



*M-30 with electronic registration for aviation fuel*



*M-25 with mechanical counter and printer*



*MA-7 with electronic registration for LPG*

### Common truck meter model numbers

Application	Description	Model
Refined fuels	2" 100-GPM aluminum-body meter with strainer/air eliminator, backcheck valve, preset valve, electronic register, and printer	M-7-CLI-1 /LCR-II
Liquefied petroleum gas (LPG)	2" 100-GPM aluminum-body meter with strainer/vapor eliminator, inlet backcheck valve, differential valve, electronic register, and printer	MA-7-CLI-10 /LCR-II
Aviation fuel	3" 300-GPM aluminum-body meter with register and printer	M-25-E-2

## Bulk plant and loading terminal meters

The larger sizes of M and MS Series meters are ideal for bulk measurement of product during loading and unloading of tanks, transports, railcars, ships, barges, and more. The MS Series meters are housed in a spherical steel case for higher system pressure applications up to 1,440 PSI. MS Series spherical case meters provide the ruggedness, accuracy, and selection of inlet/outlet configurations to handle nearly any bulk metering requirement. Meter accessories include bulk air/vapor eliminators, strainers, valves, and mechanical or electronic registers.

Turbine meters in many sizes are also available for loading terminal applications where small size due to limited available space is a consideration in meter selection.

Skid systems are designed to accommodate all necessary ancillary equipment including strainers, air eliminators, valves, and a selection of mechanical or electronic registers and load computers. Systems come fully piped and ready for installation and field calibration. Prover systems are also available built to customer specifications. Contact the factory for complete details.



MS meter with electronic registration



Turbine meter with IT400



MSA meter skid with Toptech SMP controller



### Common load rack/terminal meter model numbers

Application	Description	Model
Refined fuels	3", 350-GPM spherical-case meter with strainer/air eliminator, valve, and register	MS-30-K-1
	4", 700-GPM spherical-case meter with strainer/air eliminator, valve, and register	MS-75-K-1

## LPG and diesel fuel dispenser meters

Liquid Controls manufactures meters specially designed for high speed diesel fuel dispensers for refueling trucks as well as a meter specially designed for LPG autogas dispensers.

### High speed diesel dispenser meter

The high speed diesel dispenser meter is rated for flow rates from 12 to 60 GPM and is widely applied in diesel dispensers manufactured by a number of dispenser OEMs. Long operating life, minimal maintenance, and sustained accuracy make it the meter of choice for this demanding OEM application.

### LPG autogas dispenser meter

The MA-4 meter is specially designed for LPG autogas dispensers. It is available in two configurations: a single meter design for dispensers with one delivery hose, and a dual meter design for dispensers with two delivery hoses. The efficient, dual meter unit economizes space by utilizing a single strainer/vapor eliminator for both meters, and incorporates an integrally mounted differential valve on top of each meter. Meters are available with electronic temperature-volume compensation. The flow range for the MA-4 LPG dispenser meter is 2.5 to 40 GPM. Regulatory approvals include NTEP, NFPA 58, and UL 25. Hazardous Location Rating is Class I, Division 1, Group D (LPG).

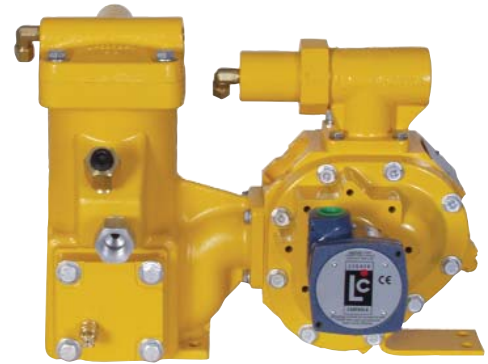

MA-4 LPG dispenser meter, single

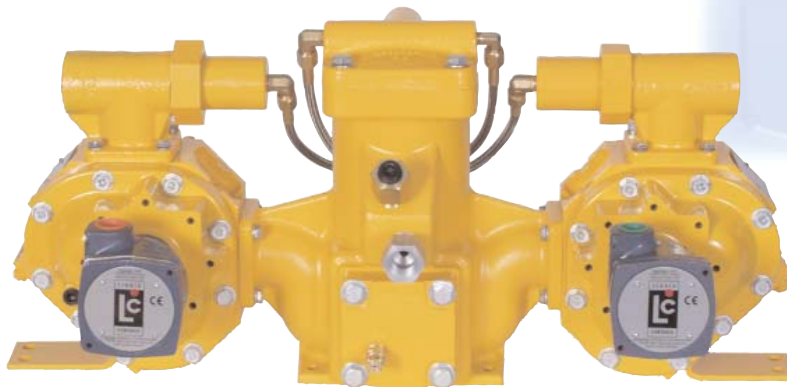

MA-4 LPG dispenser meter, dual

### Common dispenser meter model numbers

Application	Description	Model
Diesel dispenser	2", 60 GPM diesel dispenser meter	M-5
LPG autogas dispenser	1", 40 GPM LPG dispenser meter (single)	MA-4
	1", 40 GPM LPG dispenser meter (dual)*	MA-4

\*Maximum flowrate for both meters (combined) is 40 GPM.





# Specifications

---

LC meters meet NTEP (NIST Handbook 44) and many International Weights and Measures accuracy requirements, as well as U.S. Military specifications.

## Accuracy/Performance<sup>a</sup>

### Repeatability

---

Meters with Mech. registration: capable of 0.05% ( $\pm 0.025\%$ ) of reading over entire range  
Meters with Elect. registration: capable of 0.03% ( $\pm 0.015\%$ ) of reading over entire range

### Linearity

---

- Over 5:1 range  
Mech. registration: capable of  $\pm 0.125\%$  or better from max. nom. flow rate  
Elect. registration: capable of  $\pm 0.10\%$  or better from max. nom. flow rate
- Over 10:1 range  
Mech. registration: capable of  $\pm 0.22\%$  or better from max. nom. flow rate  
Elect. registration: capable of  $\pm 0.10\%$  or better from max. nom. flow rate
- Over 40:1 range  
Mech. registration: capable of  $\pm 0.5\%$  or better from max. nom. flow rate  
Elect. registration: capable of  $\pm 0.15\%$  or better from max. nom. flow rate

### Temperature range

---

-40°F to 160°F (-40°C to 71°C)

For higher temperature applications, consult factory.

<sup>a</sup> Stated accuracy obtainable when all variables remain constant. Reading/measurements reflect a minimum of one minute of flow at selected rate(s). All accuracy statements based on metering safety solvent (aliphatic hydrocarbon), approximate viscosity 1 CPS. On higher viscosity products, the average deviation in accuracy will be less.

## Construction

### Meter housing

---

M Series: aluminum, brass, cast-iron or stainless-steel

MS Series: steel case (elements by class), or stainless steel (epoxy-coated steel available for aviation and other applications)

### Meter element and rotors

---

Cast aluminum (other metallurgies available including cast iron and stainless steel)

### Internal components

---

Aluminum, Ni-Resist, stainless steel, iron

### Seal materials

---

UL recognized component: Buna-N, Viton,<sup>®</sup> PTFE<sup>®</sup>

### Bearings

---

Carbon, PTFE<sup>®</sup> Ni-Resist

Viton<sup>®</sup> and PTFE<sup>®</sup> are registered trademarks of DuPont Corporation. Victaulic<sup>®</sup> is a registered trademark of Victaulic Company.



## LC meter selection (by flow rate - NIST Standard)<sup>a</sup>

Maximum nominal flow rate <sup>b</sup>				Maximum non-shock working pressure <sup>c</sup>						Construction classes / typical application (see descriptions below)
GPM	L/min	m <sup>3</sup> /hr	Flange size	150 PSI 10.5 BAR	275 PSI 19 BAR	300 PSI 21 BAR	350 PSI 24 BAR	720 PSI 50 BAR	1,440 PSI 100 BAR	
40	151	9	1"				MA-4			10
60	227	14	1½", 2" opt.	M-5	M-5 <sup>d</sup>		MA-5			1, 2, 3, 4, 8, 10, 14, 16, 30
100	380	23	2", 1½" opt.	M-7	M-7 <sup>d</sup>		MA-7			1, 2, 3, 4, 7, 8 <sup>e</sup> , 10, 12, 14, 15, 16, 20 <sup>e</sup> , 27, 37
100	380	23	2", 1½" opt.	MS-7	MSAA-7	MSA-7		MSB-7	MSC-7	1, 2, 7, 10, 14, 16, 37
150	570	34	2"	M-10	M-10 <sup>d</sup>					1, 2
200	757	45	3"	M-15	M-15 <sup>d</sup>		MA-15			1, 2, 3, 4, 10, 14, 15, 16
200	757	45	3"	MS-15	MSA-15	MSA-15		MSB-15	MSC-15	1, 2, 8, 10, 14, 16
301	1,140	68	3"	M-25	M-25 <sup>d</sup>					1, 2
348	1,320	79	4", 3" opt.	M-30						1, 2, 3, 4, 7, 14, 15, 16, 27, 37, 47
350	1,325	79	3", 4" opt.	MS-30	MSAA-30	MSA-30		MSB-30	MSC-30	1, 2, 8, 10, 14, 16
450	1,700	102	4", 3" opt.	M-40						1, 2
450	1,700	102	3", 4" opt.	MS-40						1, 2
600	2,271	136	4", 6" opt.	M-60	M-60 <sup>d</sup>					1, 2, 3, 14, 15
700	2,650	159	4"	MS-75	MSAA-75	MSA-75		MSB-75	MSC-75	1, 2, 10, 14
800 <sup>f</sup>	3,000	182	6", 4" opt.	M-80	M-80 <sup>d</sup>					2
1,000	3,785	227	6" or 8"	MS-120	MSAA-120	MSA-120		MSB-120	MSC-120	1, 2, 8, 10, 14

<sup>a</sup> Standard LC meters (with the exception of the M-10, M-25, M-40 and M-80) are suitable for operation on products with viscosities up to 1,000,000 SSU.

<sup>b</sup> Aluminum-body meters are suitable for intermittent overspeed operation at 125% of rating for clean, lubricating fluids. Consult the factory for details.

<sup>c</sup> Maximum, non-shock working pressure ratings are based on products at temperatures below 160°F (71°C). Consult the factory for pressure ratings at elevated temperatures.

<sup>d</sup> 275 working pressure available for meter only.

<sup>e</sup> Recommended operation for Class 8 and Class 20 meters should not exceed 80% of maximum rated capacity. Recommended maximum flowrate may be less depending on viscosity.

<sup>f</sup> M-80 Class Class 2 meter may be operated at flow rates up to 1,000 GPM for a limited period of time on jet fuel only.

### Construction/application classes

<b>Class 1</b> Refined petroleum products, biodiesel	<b>Class 8</b> Acid pH liquids including: nitric, phosphoric, glacial acetic acids, citric juices, vinegar, ethanol	<b>Class 20</b> Batch process water meter service
<b>Class 2</b> Aviation and jet fuel	<b>Class 10</b> Liquefied petroleum gas (LPG)	<b>Class 27</b> Alkaline pH liquids: latex products, adhesives, liquid fertilizers
<b>Class 3</b> Variety of products including: liquid sugars, sweeteners, syrups, vegetable oils	<b>Class 12</b> Anhydrous ammonia (NH <sub>3</sub> )	<b>Class 30</b> Herbicides
<b>Class 4</b> Treated waters and solvents where no red metals are allowed	<b>Class 14</b> Crude oil, heated products, viscous liquids	<b>Class 37</b> Sodium hydroxide solutions, high sulfur crude oil, alkaline pH liquids
<b>Class 7</b> Chlorinated solvents, ethanol	<b>Class 15</b> Oil- or water-based latex products, polyester resins, adhesives, herbicides, nitrogen fertilizers	<b>Class 47</b> Mildly abrasive liquids
	<b>Class 16</b> General solvents, 200 proof alcohol, ethanol	

# Meter registration equipment

Liquid Controls provides a choice of Weights and Measures-approved mechanical or electronic registration, ticket printing, and control systems for truck-mounted or fixed-site meter applications. Both technologies provide recording functions for totalizing, inventory control, billing, batching, and ticketing.

## Electronic registration

Liquid Controls' family of LectroCount™ electronic registers provide near-perfect metering accuracy over a full range of flow rates and deliver enhanced functions including: automated data collection (e.g., date, time, product selection, delivery quantity, and more), on-site ticket generation, meter linearization, electronic temperature volume compensation, real-time communication capabilities (RF, GPS, CDPD), improved security, and more.



**LectroCount™ electronic registers**—Compatible with virtually all flow meters, the family of NEMA 4X LectroCount electronic registers is UL Class I listed and Weights and Measures approved. A simple “Run,” “Stop,” “Print” selector switch makes product delivery easy. The LectroCount LCR 600 can be upgraded to provide point-of-sale functions such as complete priced and taxed delivery tickets. LectroCount registers can also be supplied with a remote, large-character, LCD display which is viewable up to 100 ft. LectroCount is optionally available with electronic temperature volume compensation to eliminate the effect of product temperature change on measured volume. No moving parts ensures long life and accurate performance.



**LectroCount Data Management System (DMS)**—Configure tax categories and calculations, discounts, products, customers, route reports, and delivery tickets as needed. Rugged design and powerful software, the DMS can interface with three LectroCount LCR and LCR-II electronic registers and handle simultaneous deliveries on single, dual, and triple meter systems.



**Printer**—For all mobile and stationary applications from  $-22^{\circ}\text{F}$  to  $158^{\circ}\text{F}$  ( $-30^{\circ}\text{C}$  to  $70^{\circ}\text{C}$ ). Printer generates an imprinted record of the transaction which is legal for use in resale applications.



**Differential Pressure ( $\Delta\text{P}$ ) Transducer**—Monitors the differential pressure (pressure drop) across a full flow fuel monitor or a water coalescer. With the LectroCount LCR-II, prints out differential pressure readings on delivery tickets.



**Pulse output device**—Weights and Measures approved, provides a high resolution, unscaled pulse stream. The meter rotor is magnetically coupled to an optical encoder that has a signal which is directly proportional to the liquid flow through the meter. No dynamic seals to fail or leak. Easily adapts to most remote totalizers, batch controllers, computers, and other scalable pulse receiving devices.

## Mechanical registration

Mechanical registers have traditionally been used in a variety of mobile and fixed-site applications. Mechanical registers are ideal for applications without electrical power and can be installed on virtually all LC meters.



**Mechanical counter with ticket printer**—Large-numeral counter provides 5-digit resettable and 8-digit non-resettable totalizers. Printer generates an imprinted record of the transaction which is legal for use in resale applications.



**Mechanical preset counter**—Available for either single-stage or two-stage valve closure. Sets a predetermined volume and controls a mechanically linked valve. Optional microswitches convert mechanical motion to an electronic signal for control of remotely located valve, pump, and alarms.



**Counter-mounted pulser**—Supplies an electrical signal to remote totalizers, batch controllers, rate-of-flow recorders, etc. Pulser models include dry reed (1 or 10 pulses per revolution), solid state single channel (100 pulses per channel) or solid state quadrature (50 pulses per channel).



**Mechanical rate-of-flow indicator**—Direct-reading dial providing instantaneous response and dependable accuracy to within 1% of flow rate through meter. Cast aluminum case with ball bearings throughout. Readouts available in gallons, liters, and dekaliters per minute.



**Mechanical temperature volume compensator**—Uses a fluid-filled capillary system to sense product temperature and automatically correct counter reading for product volume changes due to temperature. When the temperature is 60° F, a 1:1 output ratio is supplied to the register. Output ratio is adjusted upward or downward depending on temperature fluctuation around 60° F.

# Accessories air/vapor eliminators and strainers

Liquid Controls provides a variety of precision-engineered accessories including strainers, air and vapor eliminators, and valves designed to ensure that your measuring system performs accurately and trouble-free from startup and through the long service life of the equipment. Costly measuring inaccuracies or maintenance problems can result whenever air, vapor, rust, scale, or other foreign materials are introduced into the flow of liquid.

## Air/vapor eliminators

Air and vapor eliminators are installed on the inlet side of the meter in order to maintain high-accuracy liquid measurement. The combination of an air eliminator with a downstream differential valve or air check valve minimizes the passage of air or vapor through the meter. The mechanical LC air eliminator consists of a housing that contains a float assembly in combination with flexible reed strips and two orifice plates to control elimination of free air or vapor. Air/vapor elimination is required for Weights and Measures regulatory approvals in custody transfer applications. The optical air eliminator, developed by Liquid Controls, is available for use with M-5, M-7, M-10, M-15, and M-25 meters for refined petroleum products. This system features optical sensing for liquid level detection and no moving parts for optimal field performance. The optical vapor eliminator, also developed by Liquid Controls, is available for LPG applications.

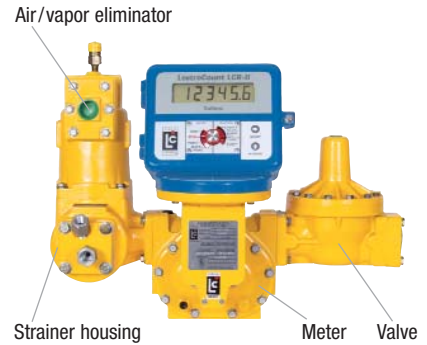

Metallurgy	Pressure rating	Used with
Aluminum	150 PSI	M-5, 7, 10, 15, 25, 30, 40, 60 meters F-7, 15, 30 strainers (petroleum)
High pressure aluminum	350 PSI	MA-4, 5, 7, 15 meters FA-7, 15 strainers (LPG)
Cast iron	150 PSI	M-7 meters F-7 strainers (chlorinated solvents & alkaline liquids)
Stainless steel	150 PSI	M-5, 7 stainless steel meters F-7 stainless steel strainers (acidic solutions)
Steel	300 PSI	MS, MSA and MSAA Series meters FS, FSA and FSAA Series strainers (MS series)
Bulk plant	150 PSI	M and MS Series meters (Choice of 3", 4", 6" and 8" flange connections)

### Typical construction details

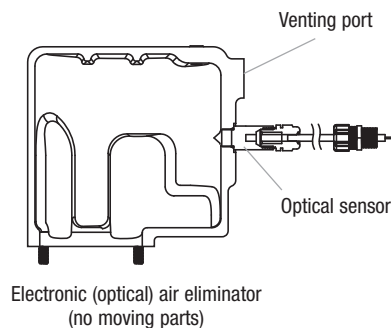
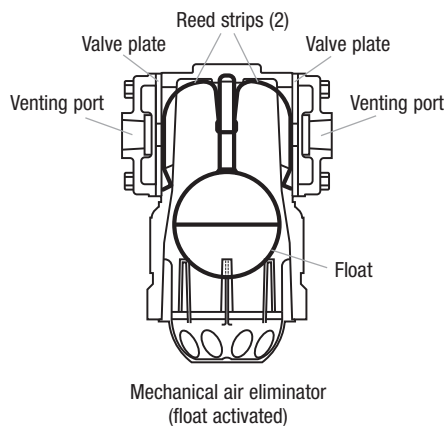

### Bulk plant air eliminators

Single head (shown) and dual head models available. Single head also available with optical sensor.





## Strainers

Strainers are always recommended for application on the inlet side of the meter to help protect against damage caused by foreign particles in the liquid: e.g., rust, pipe scale, and burrs from new piping installations. Although strainers extend the service life of the meter once in operation, systems should always be flushed and completely free of foreign material before meter installation and startup. Strainer body metallurgies include aluminum, cast iron, brass, and stainless steel.

Model	Metallurgy	Flange size	Pressure rating	Used with
F-7	Aluminum	2"	150 PSI	M-5, M-7
FA-7	Aluminum	2"	350 PSI	MA-5, MA-7
F-7	Cast iron	2"	150 PSI	M-7
F-7	Brass	2"	150 PSI	M-7
F-7	Stainless steel	2"	150 PSI	M-5, M-7
F-15	Aluminum	3"	150 PSI	M-15, M-25
FA-15	Aluminum	3"	350 PSI	MA-15
F-30	Aluminum	4"	150 PSI	M-30, M-40, M-60
FS Series	Steel	2", 3", 4" and 6"	150 PSI	MS Series meters
FSA Series	Steel	2", 3", 4" and 6"	275 PSI	MSAA Series meters
FSA Series	Steel	2", 3", 4" and 6"	300 PSI	MSA Series meters

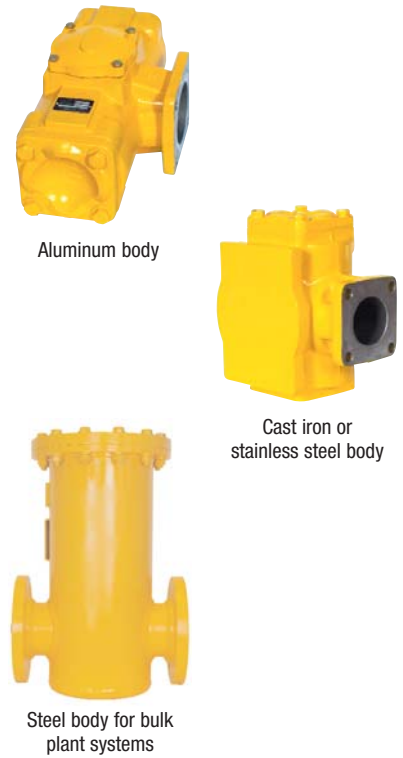

## High capacity strainers/air eliminators

A high capacity strainer/air eliminator with optional check valve is highly recommended for metering refined fuels (gasoline, fuel oil, etc.) off tank wagons for custody transfer applications. The unit installs directly to the meter inlet and facilitates passing U.S. and Canadian Weights and Measures split compartment testing. Unit uses standard 100-mesh strainer basket (3" size).

Model	Flange size	Pressure rating	Used with
F-7 (Hi-cap)	2"	150 PSI	M-7, M-10
F-15 (Hi-cap)	3"	150 PSI	M-15, M-25



## Strainer baskets

The proper strainer basket to use depends on the product and the viscosity of the product over the expected range of metering temperatures. The following table provides general application guidelines. Consult the factory for special recommendations.

Strainer mesh size	General application
200M	LPG, only
100M	Gasoline, solvents, LPG
80M	Gasoline (alternate), solvents
40M	Heating oil, diesel fuel, light oils
20M	Motor oils and other viscous products



Strainer basket

# Accessories valves

## Valves

Liquid Controls valves are designed for a wide range of applications, flow rates, and minimum head loss. Careful engineering and construction ensure smooth, accurate, and controlled operation. LC valves offer the important advantages of time-tested reliability and leak-tight shutoff.



### V- and VS-Series piston valves for refined petroleum products and industrial liquids

The V-Series mechanically actuated piston valves are available in 2" through 4" sizes and are designed for mounting on the meter outlet to provide tight shutoff with smooth and easy operation regardless of system line pressure. Valves may be manually operated or connected via a mechanical linkage to a preset counter on the meter for single stage closure, or two-stage closure to eliminate hydraulic shock. Valves are indexable in 90° increments for up, down, or side facing outlet.



### E-7 solenoid operated control valve with flow switch for refined petroleum products

The E-7 Series solenoid-operated control valves are installed at the meter outlet and are designed especially for use with Liquid Controls LectroCount<sup>3</sup>, LCR, and LCR-II electronic registers. These solenoid operated piston valves can be applied for either single or two-stage closure. The flow control switch switches the pump between low bypass and high bypass mode. Valves provide compact installation and are indexable in 90° increments for up, down, or side facing outlet.

Model	Body material <sup>a</sup>	Used with (Meter)	Companion flanges (NPT, BSPT, and slip weld)	Maximum capacity	Working pressure	Application class*
E-7 A-2900 Series	Aluminum	M-5, M-7, M-10	1½" and 2"	150 GPM (550 L/min)	150 PSI	1
V-7 A-2600 Series	Aluminum <sup>b</sup>	M-5, M-7, M-10	1½" and 2"	150 GPM (550 L/min)	150 PSI	1, 2, 3, 4, 14, 15, 16, 30
V-15 A-3600 Series	Aluminum	M-15, M-25	3"	300 GPM (1,136 L/min)	150 PSI	1, 2, 3, 4, 14, 15, 16
V-30 A-4600 Series	Aluminum	M-30, M-40, M-60	4"	600 GPM (2,271 L/min)	150 PSI	1, 2, 3, 4, 14, 15, 16
VS-3 A-36500 Series	Steel	MS-30, MS-40	3"	450 GPM (1,700 L/min)	300 PSI	1, 14
VS-4 A-46500 Series	Steel	MS-75	4"	700 GPM (2,650 L/min)	300 PSI	1, 14

<sup>a</sup>Available seal material: V-7 (Viton, Buna, PTFE); V-15/30 (Viton or PTFE); VS-3/4 (Viton).

<sup>b</sup>Cast iron, stainless steel, and brass bodies also available for V-7 valves.

\*See table on page 9.



## Differential valve for LPG and anhydrous ammonia

The differential valve—mounted on the meter outlet and connected at the valve bonnet to the vapor eliminator on the meter—functions to stop liquid flow whenever vapor is present in the system. The valve maintains sufficient pressure to ensure that high-vapor pressure products such as LPG or anhydrous ammonia (NH<sub>3</sub>) always remain in the liquid state. The valve is spring loaded and designed to fail closed.

Model	Body material	Used with (Meter)	Companion flanges (NPT, BSPT, and slip weld)	Maximum capacity	Working pressure	Application class*
A-2843	Aluminum	MA-5, MA-7, MA-15 <sup>c</sup>	1½" and 2"	200 GPM (760 L/min)	350 PSI	10, 12

<sup>c</sup>Requires use of 3" x 2" reducing flange between meter outlet and valve (part no. A3245).

\*See table on page 9.



## Solenoid operated control valve for refined petroleum products and LPG

The A-2840 (refined fuels), A-2843<sup>e</sup> (LPG), and A-2858-11 (LPG) solenoid-operated control valves are installed at the meter outlet and are designed especially for use with Liquid Controls LectroCount<sup>3</sup>, LCR, and LCR-II electronic registers. These solenoid operated diaphragm valves can be applied for either single or two-stage closure. Valve is suitable for horizontal or vertical installation without modification.

Model	Body material	Used with (Meter)	Companion flanges (NPT, BSPT, and slip weld)	Maximum capacity	Working pressure	Application class*
A-2840 Series (2-stage)	Aluminum	M-5, M-7, M-10, M-15 <sup>d</sup>	1½" and 2"	200 GPM (760 L/min)	150 PSI	1
A-2843 <sup>e</sup> (single stage)	Aluminum	MA-5, MA-7, MA-15 <sup>d</sup>	1½" and 2"	200 GPM (760 L/min)	350 psi	10
A-2858-11 (2-stage)	Aluminum	MA-5, MA-7, MA-15 <sup>d</sup>	1½" and 2"	200 GPM (760 L/min)	350 PSI	10

<sup>d</sup>Requires use of 3" x 2" reducing flange between meter outlet and valve (part no. A3245).

<sup>e</sup>Requires 82102 or 82102-24 pilot system.

\*See table on page 9.



## Air activated differential check valves

The K-Series air-activated check valves are installed on the outlet side of the meter, and are designed to stop the flow of liquid whenever air is present to ensure accurate measurement. Used where air entrapment is of particular concern in the application, such as draining tanks. Used with air eliminators with a limited bleed valve plate.

Model	Body material	Used with (Meter)	Companion flanges (NPT, BSPT, and slip weld)	Maximum capacity	Working pressure	Application class*
K-7	Aluminum <sup>e</sup>	M-5, M-7, M-15	1½" and 2"	150 GPM (550 L/min)	150 PSI	1, 2, 16, 30
K-15	Aluminum	M-15, M-25	3"	300 GPM (1,136 L/min)	150 PSI	1, 2, 16
K-30 <sup>f</sup>	Aluminum	M-30	3"	300 GPM (1,136 L/min)	150 PSI	1, 2, 16

<sup>e</sup>Cast iron and stainless steel metallurgies available for K7 series valves.

<sup>f</sup>Includes 4" to 3" reducer flange.

\*See table on page 9.

## Accessories valves



### Back check valves

The soft-seat back check valves are designed for installation at the strainer inlet (LPG) or meter outlet (refined petroleum products) and are applied to prevent reverse flow (such as during hose rewind) and to eliminate counter advancement when the truck PTO is engaged. Back check valves include a soft-seat seal and built-in pressure relief to keep the meter, downstream piping, and delivery hose packed to a set pressure. Used on all LPG truck meters and in other applications as required.

Model	Body material	Used with (Meter)	Maximum capacity	Working pressure	Application class*
A-2882, A-2885	Aluminum	M-5, M-7, M-10	100 GPM (380 L/min)	150 PSI	1
A-2883	Aluminum	MA-5, MA-7	100 GPM (380 L/min)	350 PSI	10

\*See table on page 9.



### Spring-loaded check valves for refined petroleum products

Spring loaded metal-to-metal seat check valves are designed for mounting in the outlet collar of the strainer body, between the strainer and the meter inlet. Models are available for use with the standard air eliminator or high capacity air eliminator. Check valves are applied to maintain back pressure for increasing air/vapor eliminator efficiency and to prevent reverse flow of liquid. For refined petroleum products (fuel oil, gasoline, diesel fuel, etc).

Model	Seat material	Used with (Meter)	Maximum capacity	Application class*
46743	Plated steel	M-5	60 GPM (227 L/min)	1
46735	Plated steel	M-7, M-10	100 GPM (380 L/min)	1
49891 <sup>a</sup>	Plated steel	M-7, M-10	150 GPM (550 L/min)	1
41370	Plated steel	M-15, M-25	300 GPM (1,136 L/min)	1
49896 <sup>b</sup>	Plated steel	M-15, M-25	300 GPM (1,136 L/min)	1
41380	Plated steel	M-30, M-40	450 GPM (1,700 L/min)	1

<sup>a</sup>Used with A2360. Applied on meters supplied with high-capacity air eliminator/strainer.

<sup>b</sup>Used with A3260. Applied on meters supplied with high-capacity air eliminator/strainer.

\*See table on page 9.



### Solenoid and Digital Control Valves

The 500 Series differential valve is for use with all MS, MSA and MSAA meters. The valve is offered in a steel body design with stainless steel tubing, pilot and fittings. Valves are supplied with single stage or two stage pilot operated preset control valves and operate in conjunction with mechanical and electronic presets.

Body material	Used with (Meter)	Flange connections (ANSI 150 or 300)	Working pressure	Application class*
Steel	MS, MSA, MSA Series	2", 3", 4" and 6"	150 or 300 PSI	1, 2, 10, 14, 16

\*See table on page 9.



## Accessories fittings, mountings, adapters

### Fittings, mountings and adapters

LC meters are designed and built for installation in a wide range of fixed site or mobile (truck-mounted) applications. They operate with equal accuracy whether they are configured for right, left, or angled flow, and they accept a selection of flange-mounted adapters and fittings.

**Flanges**—Available in 1½" through 4" sizes for use with all M and MA Series meters and accessories. Available in aluminum, brass, nodular iron, and stainless steel. Slip-weld versions available in aluminum, steel, and stainless steel. Optional NPT or BSPT threads available. Flanges feature O-rings for improved sealing.

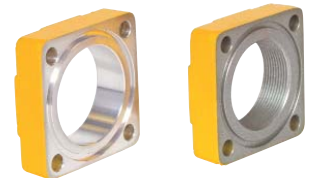

**Elbows**—Available for M-5 and M-7 meters to increase mounting flexibility for the meters and accessories. M-5 meters available with 45° and 90° rear facing elbows.



**Victaulic connections**—Used primarily in aviation refueling applications for M-60 and M-80 meters. M-60 and M-80 meters offered with 6" victaulic connections cast in body. M-60 meters available with elbows including 4" victaulic connections.



**Hot oil/steam jacket**—Consists of integral jacket and meter cover. Permits circulation of hot oil or low pressure steam to maintain product temperature within the metering chamber. For use on MS Series meters.



**Thermowell**—Available for electronic (RTD probe) temperature sensing or sensing with mechanical liquid-filled bulb. Supplied in the strainer cover assembly for M-5, M-7, M-10, M-15, M-25, M-30, and M40 or MA-4, MA-5, MA-7, and MA-15 series meters ordered with a strainer and Temperature Volume Compensation. A stainless steel, 1", female NPT model is supplied for classes 7, 27, and 37 all ferrous construction meters and class 8 stainless steel meters. MS Series meters are supplied with a 1" half coupling welded to the inlet spool to accept the Thermowell.

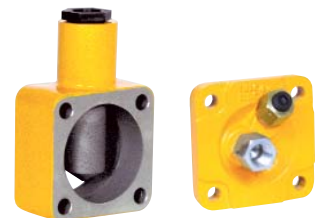

## Accessories fittings, mountings, adapters

**Swivel**—The swivel is installed below the counter or counter printer. Permits rotating counter or counter printer as desired throughout a 360° range. Designed for use with all LC meters with mechanical registers.

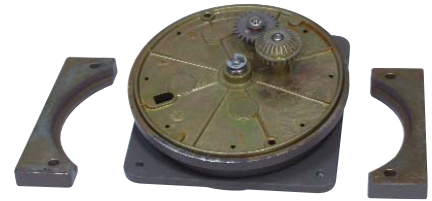

*Swivel*

**Register stack adapter and extension**—Register stack extensions are available for high temperature applications to separate the register from the meter or as required for easier reading when the meter is mounted below visible level. The 90° angle counter adapter permits register to be positioned horizontally where meters are installed in a vertical configuration. The use of a 45° counter adapter provides an upward tilt for registers positioned below normal viewing level.



*45° counter adapter shown,  
90° also available*

*Register stack  
extension (up to  
twelve inches)*

*90° counter adapter*

**Gear plate**—The gear plate is installed in the base of the mechanical counter to convert meter rotary shaft output to an engineered unit of measure. Changing units of measure is simple since all conversions are made with easily accessible gears. Designed for use with all LC meters with mechanical registers.



*Gear plate*

# Ordering information

## Model number coding description

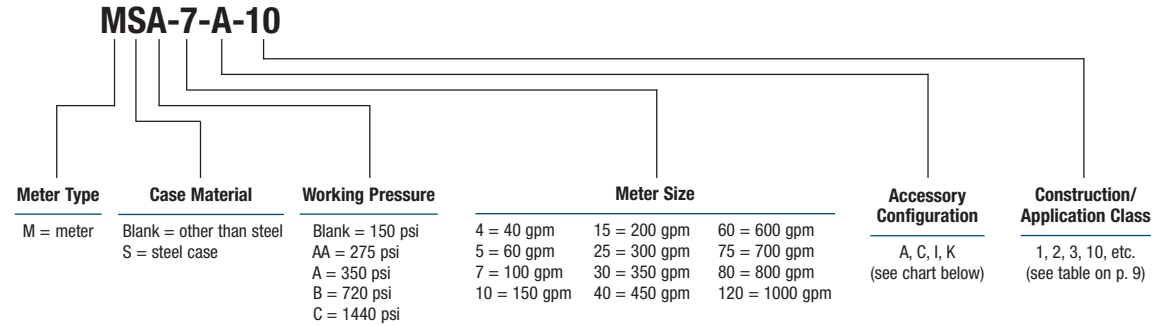

## Standard accessory configurations A, C, I, K

### M/MA-7-A

A = Meter with counter



Optional Accessories:  
Printer, Strainer

### M/MA-7-C

C = Meter with counter, strainer and air eliminator

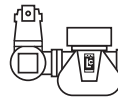

Optional Accessories: Printer

### M/MA-7-I

I = Meter with counter, preset counter and preset valve

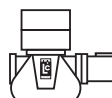

Optional Accessories: Printer, Strainer

### M/MA-7-K

K = Meter with counter, preset counter, preset valve, strainer and air eliminator

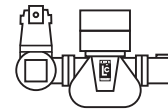

Optional Accessories: Printer

### M/MA-7-ALI

A = Meter with electronic register



Optional Accessories:  
Printer, Strainer, Valve, ETVC

### M/MA-7-CLI

A = Meter with electronic register, strainer, and air eliminator

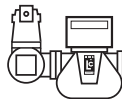

Optional Accessories: Printer, valve, ETVC

## Mounting arrangements

LC meters may be mounted in a variety of configurations, as shown below. Do not position the meter on its side, i.e., with cover plate face down or up.



**Note:** regardless of meter mounting configurations, accessories such as the air/vapor eliminator must always be mounted in a vertical orientation to permit proper operation of the float-actuated apparatus.

## Ordering

Please refer to chart above for LC model number coding system

Model	Description		
Flow rates:	Maximum	Normal	Minimum
Operating temperatures:	Maximum	Normal	Minimum
Maximum non-shock working pressure			
Maximum viscosity	@	(Temp/°F or °C)	
Specific gravity	Construction class: (1, 2, etc.)		

Direction of flow:  L to R  R to L

Seal material:

Standard Buna/Viton  All Viton  All PTFE

Read out:

Gallons  Liters  Pounds  Other \_\_\_\_\_

Strainer basket:  40M  80M  100M  200M

Other \_\_\_\_\_

Flange size: \_\_\_\_\_

Flange type:  RF or FF ANSI  DIN  Other \_\_\_\_\_

Options: \_\_\_\_\_



## The Liquid Controls Group

The Liquid Controls Group provides custody transfer solutions for the control and management of high-value fluids and gases. In 2001, IDEX united Corken, Liquid Controls and Sampi to form the Liquid Controls Group. Together, they used their combined resources to design valuable new products and offer cost-effective pump and meter solutions. The three flagship businesses laid the foundation for LCG's successful program of collaboration and innovation. With the additions of Liquid Controls Sponsler, Toptech Systems and Faure Herman, a total of six industry leading brands, LCG quickly became a dependable, single source provider, large enough to supply comprehensive solutions yet flexible enough to customize solutions for unique needs. Today, the Liquid Controls Group has a strong global presence with seven business units in five countries and over 500 distributors on six continents.

## Your Customers Are Our Customers

The Liquid Controls Group (LCG) is part of the IDEX Corporation, a diversified, engineered products company. IDEX leverages the resources of high quality, similar-profile businesses to innovate solutions that bring real and lasting value to you, our customer. At LCG and IDEX, the voice of our customers is our driving force. With your guidance, we can preserve quality and develop the products and services that best meet your customers' needs

### **LIQUID CONTROLS GROUP**

A Unit of IDEX Corporation

105 Albrecht Drive  
Lake Bluff, IL 60044-2242  
1.800.458.5262 • 847.295.1050  
Fax: 847.295.1057  
[www.liquidcontrolsgroup.com](http://www.liquidcontrolsgroup.com)



Copyright © 2005 Liquid Controls  
Pub. 100-10 (2/12)



Printed on recycled paper  
using soy inks

